

MM 640

Programmable Motion Monitor for Secure and Redundant Control of Motion Sequences



- Suitable for monitoring of overspeed, underspeed, standstill, direction of rotation, slip, shaft or gearbox fracture, impermissible motion etc.
- Six logical inputs for plausibility considerations and control of logical conditions
- Two programmable inputs for quadrature encoders A, /A, B, /B with counting frequencies up to 500 kHz
- Four programmable inputs for function control
- Four relay outputs and four high-speed transistor outputs with programmable functions and switching characteristics
- Serial RS232 and RS485 interfaces for remote access

Operating Instructions



Safety Instructions

- This manual is an essential part of the unit and contains important hints about function, correct handling and commissioning. Non-observance can result in damage to the unit or the machine or even in injury to persons using the equipment!
- The unit must only be installed, connected and activated by a qualified electrician
- It is a must to observe all general and also all country-specific and application-specific safety standards
- When this unit is used with applications where failure or maloperation could cause damage to a machine or hazard to the operating staff, it is indispensable to meet effective precautions in order to avoid such consequences
- Regarding installation, wiring, environmental conditions, screening of cables and earthing, you must follow the general standards of industrial automation industry
- - Errors and omissions excepted –

Version:	Description:
MM64001a/mb/hk_05/2008	Preliminary version
MM64001b/mb/hk_05/2008	Small corrections and improved explanations
MM64002b/mb/hk_08/2008	First final version, commands for speed selection removed
MM64003a/mb/hk_02/2009	RS485, free assignment of outputs etc.
MM64003b/pp_12/2011	Inserted new picture
MM64003c/mb/nw_09/2013	Small corrections

Table of Contents

1.	Introduction and Application	4
2.	Block Diagram and Terminal Assignment.....	5
2.1.	Power Supply	7
2.2.	Auxiliary Outputs for Encoder Supply	7
2.3.	Impulse Inputs for Incremental Encoders.....	7
2.4.	Control Inputs Input 1 – Input 4	8
2.5.	Logical Inputs Login1 - 6.....	8
2.6.	Relay Outputs and Transistor Outputs	8
2.7.	Serial Interface	9
3.	Relevant Process Data and Setpoints.....	10
3.1.	Available Actual Values	10
3.2.	Available Setpoints	11
3.3.	Available Criteria for Combination of Switching Events	11
3.4.	Generation of an Output Signal	13
4.	Setup of the Unit by PC	14
4.1.	PC connection	14
4.2.	The Main Screen	14
4.3.	Configuration of Events and Switching Functions	16
5.	Keypad Operation	18
5.1.	Normal Operation	18
5.2.	General Setup Procedure.....	18
5.3.	Change of Parameter Values on the Numeric Level	20
5.4.	Code Protection against Unauthorized Keypad Access	21
5.5.	Return from the Programming Levels and Time-Out Function	21
5.6.	Reset all Parameters to Factory Default Values	21
6.	Menu Structure and Description of Parameters	22
6.1.	Summary of the Menu	22
6.2.	Description of the Parameters	24
7.	Description of Commands	34
8.	Hints for Scaling of the Unit.....	36
8.1.	Speed Scaling	36
8.2.	Standstill Definition (Wait-Time)	37
8.3.	Scaling of the Position Counters	37
9.	Specifications	38
10.	Dimensions	39
11.	Serial Code List.....	40
11.1.	Parameters and Settings	40
11.2.	Control Commands	44
11.3.	Actual Process Values	44

1. Introduction and Application

The MM640 motion monitor has been designed for monitoring and control of admissible and impermissible operating conditions on machinery systems like conveyors, hoisting devices and many more. This unit is not just a speed monitor, but provides comparison between peripheral motion, motor motion and scheduled demand values of the control system. The unit is designed to generate OK signals or alarms upon programmable peripheral conditions. It provides four relay outputs and four transistor outputs.

6 logical inputs can pick up remote commands or peripheral states, and this information can be included into the combination of events for setting or resetting alarms.

The example below shows a hoisting unit where a motor moves the load up and down, via gearbox or other mechanical transmission.

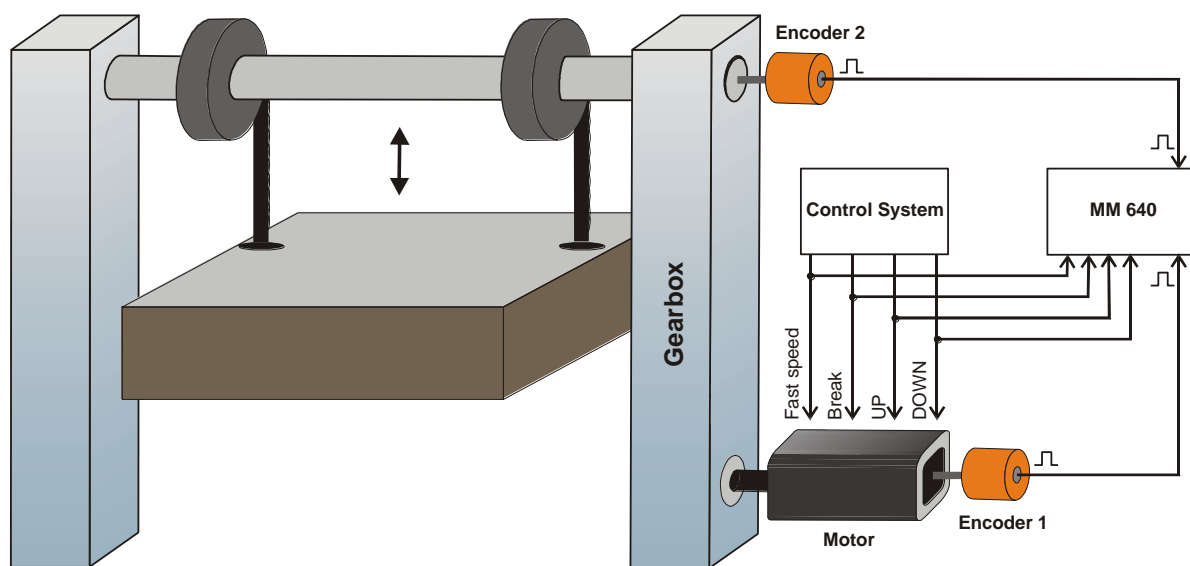

In a situation like shown the MM640 unit could e.g. provide the following alarms:

- The motor is in standstill, but the load is still moving (gearbox problem)
- The speed command is "UP" but the load does not move at all or even moves into the wrong direction
- No speed command is applied and the break is engaged, but still the motor or the load are moving (break problem)
- The command is "Slow Speed Down" but the actual speed of the load exceeds the permissible "Slow Speed" limit
- the displacement of the load indicated by encoder 2 does not match up with the number of pulses generated by encoder 1, with consideration of the gearbox ratio (slip problem)

Furthermore the MM640 can take over limit switch functions for the permissible upper and lower positions of the load etc. All desired functions can be easily configured by PC, just by clicking a few checkboxes in a "logical AND / OR" matrix on the screen.

2. Block Diagram and Terminal Assignment

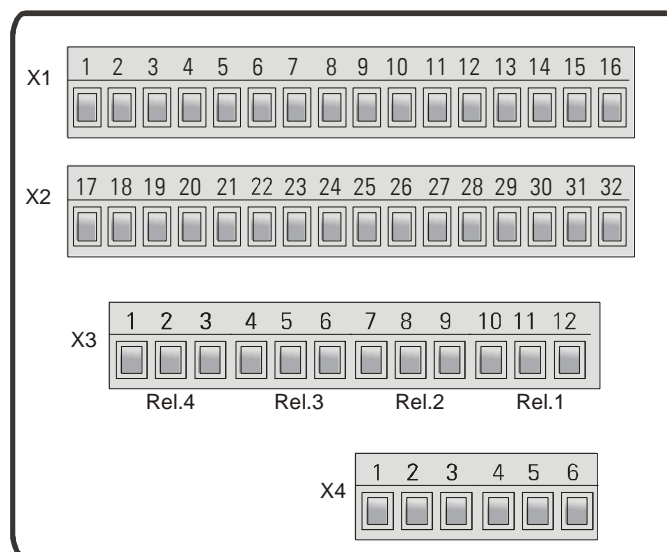
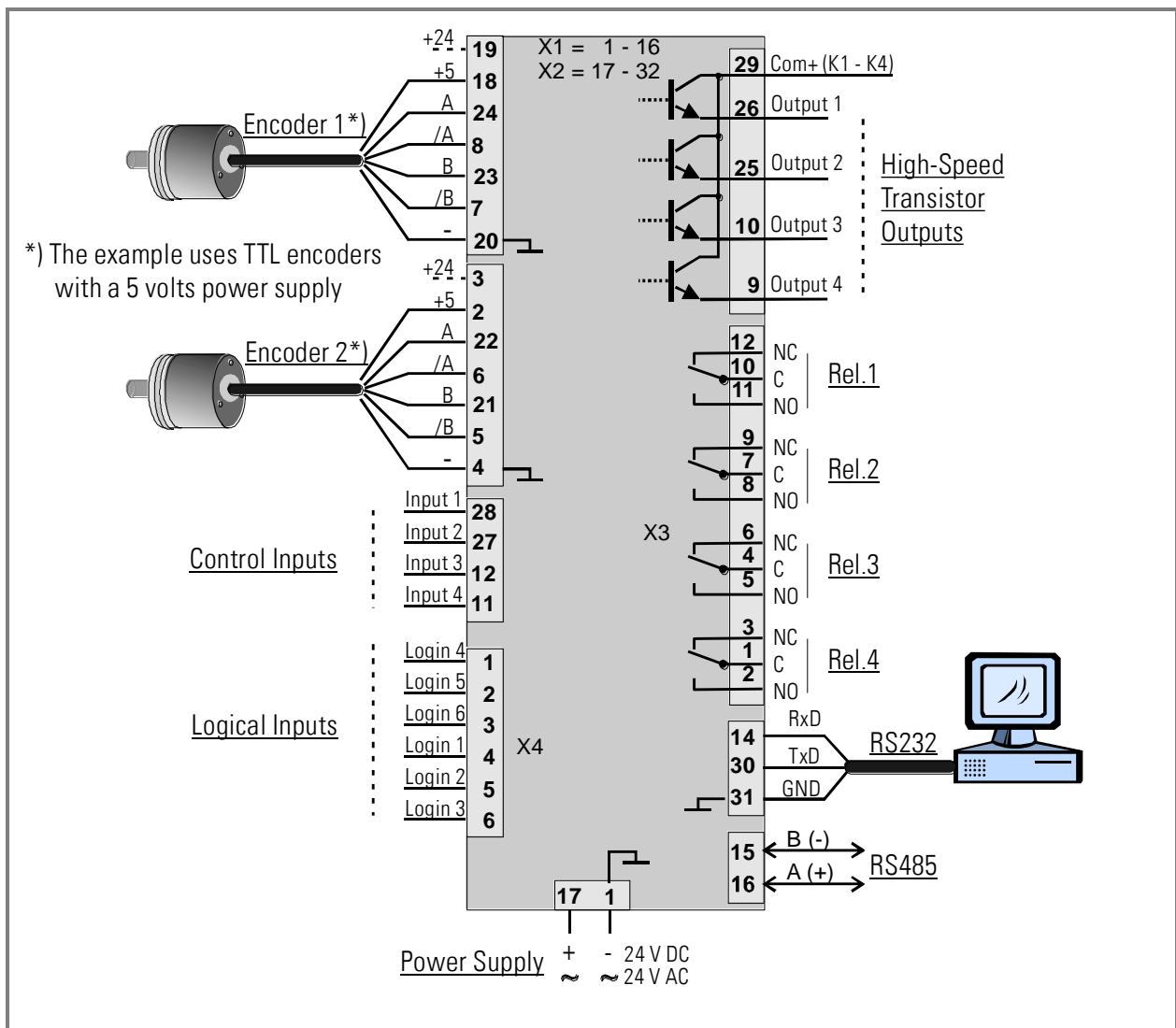

Terminal	Name	Function
01	GND	Common Ground Potential (0V)
02	+5,2V out	Aux. output 5.2V/150 mA for encoder supply
03	+24V out	Aux. output 24V/120 mA for encoder supply
04	GND	Common Ground Potential (0V)
05	Encoder 2, /B	Encoder 2, channel /B (B inverted)
06	Encoder 2, /A	Encoder 2, channel /A (A inverted)
07	Encoder 1, /B	Encoder 1, channel /B (B inverted)
08	Encoder 1, /A	Encoder 1, channel /A (A inverted)
09	K4 out	Digital output K4, transistor PNP 30 volts, 350 mA
10	K3 out	Digital output K3, transistor PNP 30 volts, 350 mA
11	Cont.4	Programmable control input
12	Cont.3	Programmable control input
13	(PROG)	(for download of new firmware only, not for general use)
14	RxD	Serial RS232 interface, input (Receive Data)
15	RS485 B (-)	RS 485 serial interface
16	RS485 A (+)	RS 485 serial interface
17	+Vin	Power supply input, +17 – 40 VDC or 24 VAC
18	+5,2V out	Aux. output 5,2V/150 mA for encoder supply
19	+24V out	Aux. output 24V/120 mA for encoder supply
20	GND	Common Ground Potential (0V)
21	Encoder 2, B	Encoder 2, channel B (non-inverted)
22	Encoder 2, A	Encoder 2, channel A (non-inverted)
23	Encoder 1, B	Encoder 1, channel B (non-inverted)
24	Encoder 1, A	Encoder 1, channel A (non-inverted)
25	K2 out	Digital output K2, transistor PNP 30 volts, 350 mA
26	K1 out	Digital output K1, transistor PNP 30 volts, 350 mA
27	Cont.2	Programmable control input
28	Cont.1	Programmable control input
29	Com+ (K1-K4)	Common positive input for transistor outputs K1-K4
30	TxD	Serial RS232 interface, output (Transmit Data)
31	GND	Common Ground Potential (0V)
32	GND	Common Ground Potential (0V) for DC or AC power supply

*) 120 mA and 150 mA are per encoder, i.e. total maximum currents are 240 mA and 300 mA

2.1. Power Supply

The MM640 monitor accepts both, a 17 – 40 volts DC power or a 24 volts AC power for supply via terminals 17 and 1. The current consumption depends on the level of the input voltage and some internal conditions; therefore it can vary in a range from 100 – 200 mA (aux. currents taken from the unit for encoder supply not included).

2.2. Auxiliary Outputs for Encoder Supply

Terminals 2 and 18 provide an auxiliary output with approx. +5.2 volts DC (300 mA totally).
Terminals 3 and 19 provide an auxiliary output with approx. +24 volts DC (240 mA totally)

2.3. Impulse Inputs for Incremental Encoders

All input characteristics of the impulse inputs can be set by the parameter menu, for each of the encoders separately.

Due to the high safety demands made on this unit it is mandatory to use quadrature encoders only (A, B or A, /A, B, /B, 90°).

The following levels and impulse standards can be used:

- Symmetric input (differential) according to RS422 standard
- TTL inputs at a level of 3.0 to 5 volts (differential, with inverted signal)
- TTL inputs at a level of 3.0 to 5 volts (single-ended) *)
- HTL signals at a 10 – 30 volts level
(alternatively differential with inverted signals A, /A, B, /B, or single-ended A, B only)
*) requires special settings of the threshold parameters, see “Special parameters F10”



- For all applications it is mandatory to use quadrature encoders with channels A and B or with channels A, /A, and B, /B (90° phase displacement).
- Where the impulse level is HTL (10 – 30 volts) you can use either single-ended signals (A and B only) or differential signals (A, /A, B, /B)
- Where the impulse level is TTL, it is strictly recommended to use symmetric differential signals (with inverted channels /A and /B).
Under industrial environment conditions, single-ended TTL signals may cause serious problems due to insufficient EMC immunity of the signal lines

2.4. Control Inputs 1 – 4

These inputs can be configured for remote functions like Reset, disable of the keyboard or display selection purpose etc.

All control inputs require HTL level (12 ... 30 volts). The characteristics can be individually set to either NPN (switch to -) or PNP (switch to +). For applications where edge-triggered action is needed, the menu allows to set the active edge (rising or falling). The control inputs will also accept signals with Namur (2-wire) standard.



For reliable operation of the control inputs, minimum impulse duration of 50 µsec. must be ensured.

Please verify that this minimum duration will be kept even at maximum speed of the machine

2.5. Logical Inputs Login1 - 6

The logical inputs are available for process control. These inputs receive logical information from the process (e.g. that the actual operator command for a motor is "forward"). The monitor can use this information together with the encoder feedback to check if the operator command is executed correctly or not.

Each input is equipped with a programmable switch-on and switch-off delay, in order to allow an applicable response time to the mechanics before comparing the actual state and the scheduled state.

All logical inputs operate at HTL level (12 ... 30 volts) with PNP (switch to +) characteristics.

2.6. Relay Outputs and Transistor Outputs

The unit provides four relay outputs and four independent transistor outputs. The user is free to assign each of the four programmable control functions and each of the four internal status signals to any of the relays or outputs.

Whilst the relay (dry change-over) will need a switching delay of 5 - 10 msec. the corresponding transistor output will provide the same information much faster (< 1 msec.)

All desired control functions or switching conditions are programmable by PC.

The OS32 operator software provides integration of any kind of logical combination of input signals (nominal condition) and feedback signals (real condition) into the process.

After specification of the desired events to be used for control, it is possible to still add any of the following characteristics to the resulting switching functions:

- Response delay: when the switching event occurs, the output will still wait for a programmable time until it responds
- Timed or static operation: when the event occurs, the output can provide either dynamic (timed) operation or static operation

- All functions may be set to positive response (switch ON upon switching event) or negative response (switch OFF upon switching event)
- Catch function: all functions may be set to lock in the active position (e.g. remain continuously ON or continuously OFF) until to acknowledgement by a remote reset signal

Output 1 to Output 4 are fast-switching, short-circuit-proof transistor outputs with a switching capability of 5 – 30 volts / 350 mA each. The switching voltage of the outputs must be applied remotely to the Com+ input (terminal 29)

The relays Rel1 to Rel4 provide dry changeover contacts at a switching capability of maximum 250 V/ 1 A/ 250 VA (AC) or maximum 100 V/ 1A/ 100 W (DC)

2.7. Serial Interface

The serial RS232 interface can be used for the following purposes:

- Set-up of the unit by PC by means of the OS32 PC software
- Change of parameters during operation
- Readout of actual speeds or positions or other counter values by PLC or PC
- Running of functional checks of the monitor, under remote control of a superior system

The figure below shows how to connect the MM640 monitor to a PC or a PLC

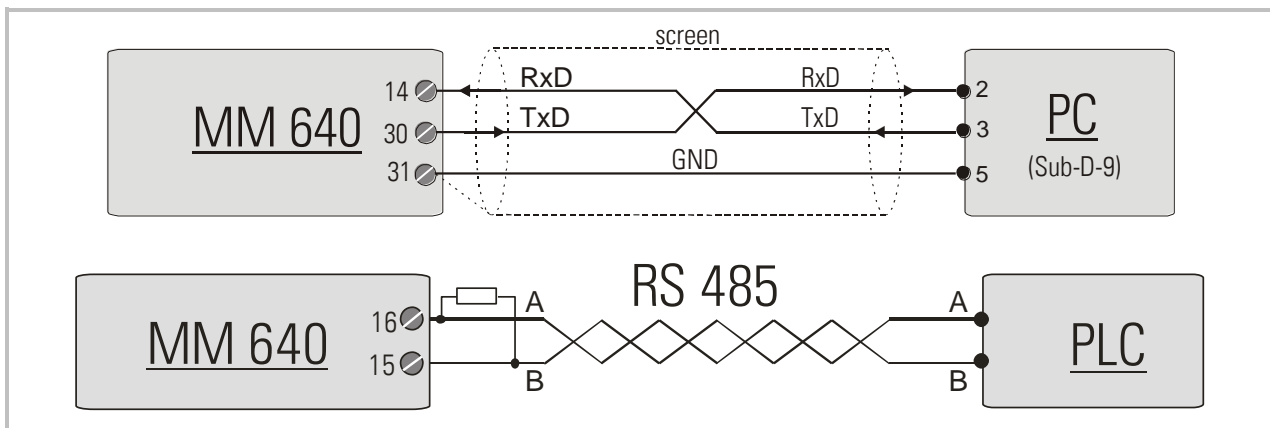

Both serial interfaces can be connected at the same time.
However only the one or the other must communicate at a time.
It is not possible to communicate simultaneously with both interfaces

3. Relevant Process Data and Setpoints

3.1. Available Actual Values

Depending on the connected encoders and sensors, the monitor continuously measures and updates the actual values shown in the list below. This means that every of these actual values is available at any time for evaluation and can be combined with other functions to switch one of the outputs ON or OFF.

Value/State	Description	Requirement
Standstill 1	Digital information (yes/no) for zero motion of encoder 1 *)	Incremental signal on Encoder 1 input
Motion signal 1	Digital information (yes/no) for active motion of encoder 1	Incremental signal on Encoder 1 input
Speed 1	Actual speed of encoder 1 according to customer scaling	Incremental signal on Encoder 1 input
Position 1	Actual position count of encoder 1 according to customer scaling **)	Quadrature encoder for encoder input 1
Direction 1	Direction of motion (forward or reverse) of encoder 1	Quadrature encoder for encoder input 1
Standstill 2	Digital information (yes/no) for zero motion of encoder 2 *)	Incremental signal on Encoder 2 input
Motion signal 2	Digital information (yes/no) for active motion of encoder 2	Incremental signal on Encoder 2 input
Speed 2	Actual speed of encoder 2 according to customer scaling	Incremental signal on Encoder 2 input
Position 2	Actual position count of encoder 2 according to customer scaling **)	Quadrature encoder for encoder input 2
Direction 2	Direction of motion (forward or reverse) of encoder 2	Quadrature encoder for encoder input 2
Difference Pos 1 - Pos 2	Differential position count between encoder 1 and encoder 2, according to customer scaling **)	Quadrature encoders for both, encoder 1 and encoder 2

*) Standstill can be defined by parameter setting

**) "Zero position" and "Zero difference" can be defined by individual RESET

3.2. Available Setpoints

For configuration of the switching conditions of the relays, the following setpoints are available. Every setting is individual for each of the four switching functions, i.e. there are totally $4 \times 7 = 28$ programmable setpoints available. Settings can be omitted if the corresponding setpoints have not been assigned to a switching function.

Setpoint	Description
Set Speed 1.1	Set Speed 1 for Encoder 1
Set Speed 1.2	Set Speed 2 for Encoder 1
Set Speed 2.1	Set Speed 1 for Encoder 2
Set Speed 2.2	Set Speed 2 for Encoder 2
Setpoint Counter 1	Position setpoint for Encoder 1
Setpoint Counter 2	Position setpoint for Encoder 2
Differential Setpoint	Differential position setpoint (encoder 1 – encoder 2)

3.3. Available Criteria for Combination of Switching Events

The monitor provides totally four different switching functions, each of them consisting of up to four different switching events. If an event becomes true the monitor will set the corresponding output according to the selected output assignment.

3.3.1. Logical switching conditions

Event	Description of the Switching Condition
Login1 or /Login1	All functions allow gating with one or several of the 6 logical Inputs. <ul style="list-style-type: none"> - Login X means that a "HIGH" signal is needed to make the condition true - /Login X means that a "LOW" signal is needed to make the condition true
Login2 or /Login2	
Login3 or /Login3	
Login4 or /Login4	
Login5 or /Login5	
Login6 or /Login6	

3.3.2. Speed related switching conditions

Event	Description of the Switching Condition
$[v1] \leq \text{Set Speed1.1}$	The absolute value of the actual encoder1 speed is lower or equal to the set speed 1.1
$[v1] \geq \text{Set Speed1.1}$	The absolute value of the actual encoder1 speed is higher or equal to the set speed 1.1
$[v1] \geq \text{Set Speed1.2}$	The absolute value of the actual encoder1 speed is higher or equal to the set speed 1.2
$[v1] = 0$	Speed of encoder1 = zero (standstill according to standstill definition)
$[v1] \neq 0$	Speed of encoder1 \neq zero (encoder1 is in motion)
$[v2] \leq \text{Set Speed2.1}$	The absolute value of the actual encoder2 speed is lower or equal to the set speed 2.1
$[v2] \geq \text{Set Speed2.1}$	The absolute value of the actual encoder2 speed is higher or equal to the set speed 2.1
$[v2] \geq \text{Set Speed2.2}$	The absolute value of the actual encoder2 speed is higher or equal to the set speed 2.2
$[v2] = 0$	Speed of encoder2 = zero (standstill according to standstill definition)
$[v2] \neq 0$	Speed of encoder2 \neq zero (encoder2 is in motion)

3.3.3. Position related switching conditions

Event	Description of the Switching Condition
$[c1] \geq \text{Setpoint Counter1}$	The absolute value of the actual encoder1 counter is higher or equal to "Position Setpoint 1" of the corresponding function
$[c1] \leq \text{Setpoint Counter1}$	The absolute value of the actual encoder1 counter is lower or equal to "Position Setpoint 1" of the corresponding function
$[c2] \geq \text{Setpoint Counter2}$	The absolute value of the actual encoder2 counter is higher or equal to "Position Setpoint 2" of the corresponding function
$[c2] \leq \text{Setpoint Counter2}$	The absolute value of the actual encoder2 counter is lower or equal to "Position Setpoint 2" of the corresponding function

3.3.4. Direction related switching conditions

Event	Description of the Switching Condition
$c1 = + + +$	Counter 1 counts upwards, Direction1 = Forward
$c1 = - - -$	Counter 1 counts downwards, Direction1 = Reverse
$c2 = + + +$	Counter 2 counts upwards, Direction2 = Forward
$c2 = - - -$	Counter 2 counts downwards, Direction2 = Reverse

3.3.5. Differential switching conditions

Event	Description of the Switching Condition
$[c1 - c2] \geq \text{Differential Setpoint}$	The absolute value of the differential position between encoder1 and encoder2 is higher or equal to the differential position setpoint of the corresponding function
$[c1 - c2] \leq \text{Differential Setpoint}$	The absolute value of the differential position between encoder1 and encoder2 is higher or equal to the differential position setpoint

3.4. Generation of an Output Signal

As a first step we have to arrange the desired Switching Events, which can be composed from any combination of the switching conditions as described above. Every event consists of one or several conditions according to the selection of check boxes on the PC screen (see 4.3). Several events (1 - 4) are combined to a Switching Function. The parameters named "Target Function" allow the assignment of an output to each function, where the switching signal finally appears. Also the internal status bits become accessible via output if a corresponding assignment has been made. The assignment of outputs uses an 8-bit binary code as shown below.

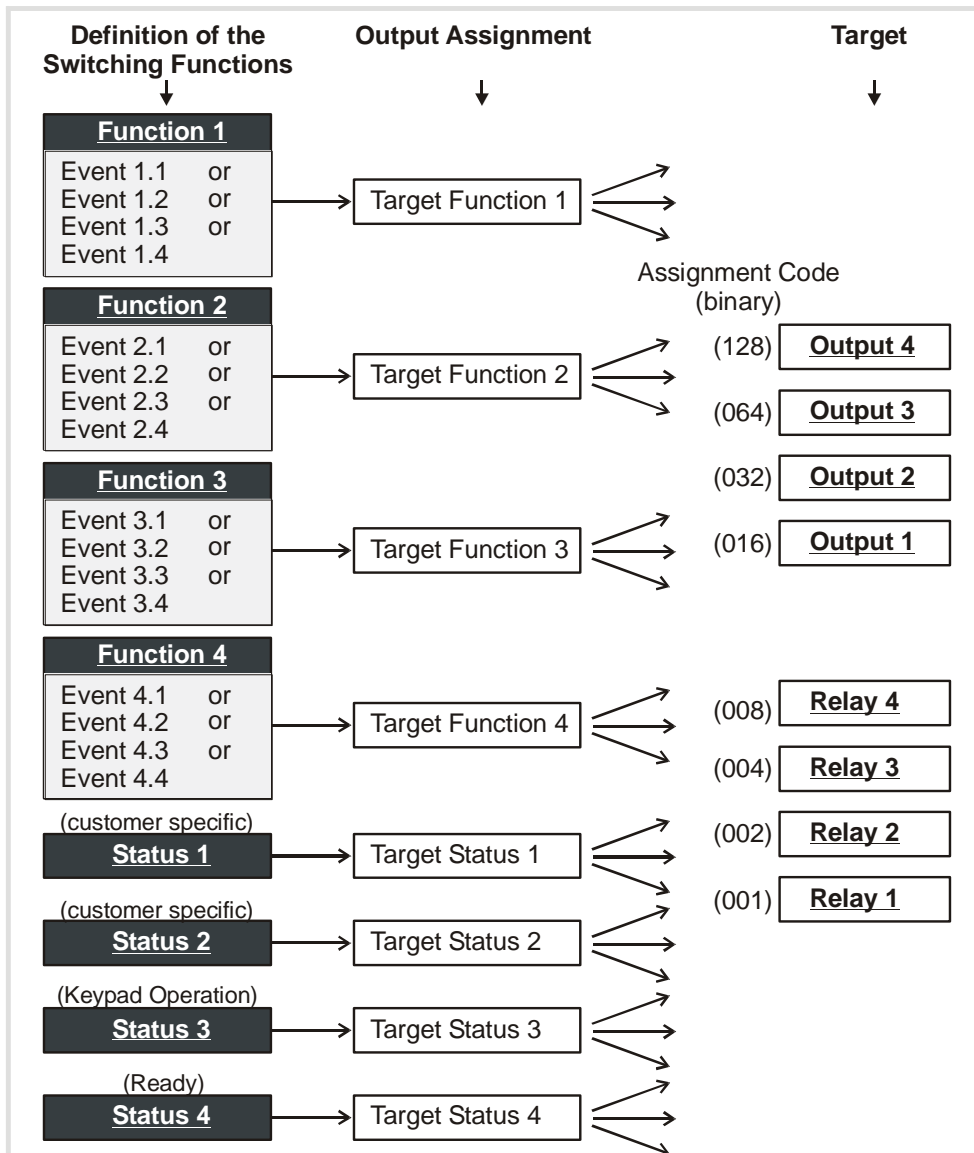

4. Setup of the Unit by PC

4.1. PC connection

For initial setup of the MM640 Motion Monitor a PC with the motrona OS32 operator software is required (Software version OS32_1t or higher). This software is included on CD and is also available for free download from our homepage www.motrona.com.

The software allows to set all basic parameters and to assign the desired switching functions to the outputs. During later operation, the four programming keys on the front side of the unit can be used to change settings like Setpoints or scaling parameters (see 5.).

Connect your PC to the monitor as shown in chapter 2.7 and start the OS32 software. The adjoining screen will appear.

If your text and color fields remain empty and the headline says „OFFLINE“, you must verify your serial settings. To do this, select “Comms” from the menu bar.



- Ex factory, all motrona units use the following serial standard settings:
Unit No. 11, Baud rate 9600, 1 start/ 7 data/ parity even/ 1 stop bit
- If the serial settings of your unit should be unknown, you can run the “SCAN” function from the „TOOLS“ menu to find out.

4.2. The Main Screen

The edit window for all unit parameters can be found on the left side of the screen. To enter your parameters, please click to the corresponding line, enter a new value and save the new value by pressing ENTER on your PC keyboard.

You can also just change all digits according to need, then finally click to the Softkeys “Transmit All” followed by “Store EEPROM” to save all your settings.

The INPUTS field provides Softkeys to switch the control commands on or off. Display boxes in the RS column indicate when the corresponding command is set to ON by PC. Display boxes in the PI/O column indicate that commands assigned to the hardware inputs (input1 to input4) are switched ON by external signal.

The OUTPUT field informs about the actual state of the four outputs and the four relays.

PARAMETERS

Command-Setting	00
Key Up Action	00
Key Down Action	00
Key Enter Action	04
Input 1 Configuration	5
Input 1 Action	09
Input 2 Configuration	5
Input 2 Action	01
Input 3 Configuration	5
Input 3 Action	02
Input 4 Configuration	3
Input 4 Action	03
Target Function 1	1
Target Function 2	2
Target Function 3	3
Target Function4	4
Target Status 1	1
Target Status 2	2
Target Status 3	3
Target Status 4 (Ready)	8
Release Action	00
Freeze Action	15
Reserved	000000

INPUTS

Reset Counter A

Reset Counter B

Reset Difference

Scroll Display

Activate Data

Keyboard Disable

Store EEPROM

Release Function Lock

Freeze Function

Cmd 10

Cmd 11

Cmd 12

Cmd 13

Cmd 14

Cmd 15

RS

BUS

PI/D

OUTPUTS

Output 4

Output 3

Output 2

Output 1

Relay 4

Relay 3

Relay 2

Relay 1

DIFFERENTIAL COUNTER

+102

-50 0 +50

SERIAL SETTINGS

COM 1 9600, 7, 1, E Unit 11

CONTROLS

Read

Transmit

Transmit All

Store EEPROM

Reset is OFF

PO

4.3. Configuration of Events and Switching Functions

To open the Assignment screen, select "Config. MM" from the Tools Menu.

You can set any combination of switching events and functions by choosing corresponding combinations of the conditions as described before.

In the "Options" column you find a list of all actual motion conditions according to the current encoder information. Checkboxes allow to activate the corresponding event as one of the desired switching conditions. Just click the corresponding box to switch it on or off.



- All checkboxes of a vertical column operate "**Logical AND**" and form a **Switching Event**.
- Always four adjoining columns (events) operate "**Logical OR**" and form a **Switching Function**. If one or several of the events become true, the switching function will become active.
- You are free to activate any number and combination of checkboxes. Setting checkboxes with conflictive conditions must however be avoided. *)
- The destination output for each switching function can be set by means of the parameter "Target Function".
It is possible to assign different switching functions to the same output (e.g. Function1 => Relay1 and Function2 => Relay1)
Likewise it is possible to assign several outputs to the same switching function (e.g. Function1 => Relay1 and Relay2)

*) Where e.g. you would set both checkboxes "v=0" and "v≠0" at the same time, this would result in a conflict where the corresponding output would never switch off.

The adjoining screenshot shows the following four events to activate Switching Function 1:

Login1 = LOW and Login2 = High and Encoder1 = Standstill

(event 1.1)

or

Login2 = High and Speed1 >= Set Speed1.1 and Forward motion of Encoder1

(event 1.2)

or

Login3 = High

(event 1.3)

or

Reverse motion of Encoder 2

(event 1.4)





It is easy to understand how many possibilities of monitoring speeds and events result from this simple method of programming.

Options	Function1	Function2	Function3	Function4	Buttons
/Login 1 (low)	1.1 <input checked="" type="checkbox"/>	2.1 <input type="checkbox"/>	3.1 <input type="checkbox"/>	4.1 <input type="checkbox"/>	<div style="display: flex; justify-content: space-around; border-bottom: 1px solid black; padding-bottom: 5px;"> Leave without save Exit Transmit </div>
/Login 2 (low)	1.2 <input type="checkbox"/>	2.2 <input type="checkbox"/>	3.2 <input type="checkbox"/>	4.2 <input type="checkbox"/>	
/Login 3 (low)	1.3 <input type="checkbox"/>	2.3 <input type="checkbox"/>	3.3 <input type="checkbox"/>	4.3 <input type="checkbox"/>	
/Login 4 (low)	1.4 <input type="checkbox"/>	2.4 <input type="checkbox"/>	3.4 <input type="checkbox"/>	4.4 <input type="checkbox"/>	
/Login 5 (low)	<input type="checkbox"/>	<input type="checkbox"/>	<input type="checkbox"/>	<input type="checkbox"/>	
/Login 6 (low)	<input type="checkbox"/>	<input type="checkbox"/>	<input type="checkbox"/>	<input type="checkbox"/>	
Login 1 (high)	<input type="checkbox"/>	<input type="checkbox"/>	<input type="checkbox"/>	<input type="checkbox"/>	
Login 2 (high)	<input checked="" type="checkbox"/>	<input type="checkbox"/>	<input type="checkbox"/>	<input type="checkbox"/>	
Login 3 (high)	<input type="checkbox"/>	<input type="checkbox"/>	<input type="checkbox"/>	<input type="checkbox"/>	
Login 4 (high)	<input type="checkbox"/>	<input type="checkbox"/>	<input type="checkbox"/>	<input type="checkbox"/>	
Login 5 (high)	<input type="checkbox"/>	<input type="checkbox"/>	<input type="checkbox"/>	<input type="checkbox"/>	
Login 6 (high)	<input type="checkbox"/>	<input type="checkbox"/>	<input type="checkbox"/>	<input type="checkbox"/>	
V1 <= Set Speed 1.1	<input type="checkbox"/>	<input type="checkbox"/>	<input type="checkbox"/>	<input type="checkbox"/>	
V1 >= Set Speed 1.1	<input checked="" type="checkbox"/>	<input type="checkbox"/>	<input type="checkbox"/>	<input type="checkbox"/>	
V1 >= Set Speed 1.2	<input type="checkbox"/>	<input type="checkbox"/>	<input type="checkbox"/>	<input type="checkbox"/>	
V1 = 0	<input checked="" type="checkbox"/>	<input type="checkbox"/>	<input type="checkbox"/>	<input type="checkbox"/>	
V1 != 0	<input type="checkbox"/>	<input type="checkbox"/>	<input type="checkbox"/>	<input type="checkbox"/>	
V2 <= Set Speed 2.1	<input type="checkbox"/>	<input type="checkbox"/>	<input type="checkbox"/>	<input type="checkbox"/>	
V2 >= Set Speed 2.1	<input type="checkbox"/>	<input type="checkbox"/>	<input type="checkbox"/>	<input type="checkbox"/>	
V2 >= Set Speed 2.2	<input type="checkbox"/>	<input type="checkbox"/>	<input type="checkbox"/>	<input type="checkbox"/>	
V2 = 0	<input type="checkbox"/>	<input type="checkbox"/>	<input type="checkbox"/>	<input type="checkbox"/>	
V2 != 0	<input type="checkbox"/>	<input type="checkbox"/>	<input type="checkbox"/>	<input type="checkbox"/>	
Z1 >= Setpoint Counter 1	<input type="checkbox"/>	<input type="checkbox"/>	<input type="checkbox"/>	<input type="checkbox"/>	
Z1 <= Setpoint Counter 1	<input type="checkbox"/>	<input type="checkbox"/>	<input type="checkbox"/>	<input type="checkbox"/>	
Z1 = ++	<input checked="" type="checkbox"/>	<input type="checkbox"/>	<input type="checkbox"/>	<input type="checkbox"/>	
Z1 = --	<input type="checkbox"/>	<input type="checkbox"/>	<input type="checkbox"/>	<input type="checkbox"/>	
Z2 >= Setpoint Counter 2	<input type="checkbox"/>	<input type="checkbox"/>	<input type="checkbox"/>	<input type="checkbox"/>	
Z2 <= Setpoint Counter 2	<input type="checkbox"/>	<input type="checkbox"/>	<input type="checkbox"/>	<input type="checkbox"/>	
Z2 = ++	<input type="checkbox"/>	<input type="checkbox"/>	<input type="checkbox"/>	<input type="checkbox"/>	
Z2 = --	<input type="checkbox"/>	<input type="checkbox"/>	<input type="checkbox"/>	<input type="checkbox"/>	
Z1-Z2 >= Differential Setpoint	<input type="checkbox"/>	<input type="checkbox"/>	<input type="checkbox"/>	<input type="checkbox"/>	
Z1-Z2 <= Differential Setpoint	<input type="checkbox"/>	<input type="checkbox"/>	<input type="checkbox"/>	<input type="checkbox"/>	

5. Keypad Operation

An overview of all parameters and explanations can be found under section 6.

The menu of the unit uses four keys, hereinafter named as follows:

			
PROG	UP	DOWN	ENTER

Key functions depend on the actual operating state of the unit. Essentially we have to describe two basic states:

- Normal operation
- General setup procedure

5.1. Normal Operation

In this mode the unit operates as a motion monitor according to the settings defined upon setup. All front keys may have customer-defined functions according to the specifications met in the keypad definition menu F08 (e.g. Reset, Display selection or else). During normal operation the internal status "Ready" indicates the operating state of the unit.









5.2. General Setup Procedure

The unit changes over from normal operation to setup level when keeping the  key down for at least 2 seconds. Thereafter you can select one of the parameter groups F01 to F11.

Inside the group you can now select the desired parameter and set the value according to need. After this you can either set more parameters or return to the normal operation.

During all setup operations by keypad the "Ready" status is OFF while the "Keypad Operation" status is ON.

The adjoining sequence of key operations explains how to change **Parameter number 052 of group F06 from the original value of 0 to a new value of 8**





Step	State	Key action		Display	Comment
00	Normal operation			Actual Display Value	
01			> 2 sec.	F01	Display of the Parameter group
02	Level: Parameter group		5 x	F02 ... F06	Select group # F06
03				F06.050	Confirmation of F06. The first parameter of this group is F06.050
04	Level: Parameter numbers		2 x	F06.051 ... F06.052	Select parameter 052
05				0	Parameter 052 appears in display, actual setting is 0
06	Level: Parameter values		8 x	1 8	Setting has been modified from 0 to 8
07				F06.052	Save the new setting (8)
08	Level: Parameter numbers			F06	Return to level parameter groups
09	Level: Parameter groups			Actual Display value	Return to normal operation
10	Normal operation				



During the general setup procedure all control activities remain disabled. New parameter settings become active after return to normal operation only.

5.3. Change of Parameter Values on the Numeric Level











The numeric range of the parameters is up to 6 digits. Some of the parameters may also include a sign. For fast and easy setting of these values the menu uses an algorithm as shown subsequently. During this operation the front keys have the following functions:

			
PROG	UP	DOWN	ENTER
Saves the actual value shown in the display and returns to the parameter selection level	Increments the highlighted (blinking) digit	Decrements the highlighted (blinking) digit	Shifts the cursor (blinking digit) one position to the left, or from utmost left to right

With signed parameters the left digit scrolls from **0 to 9** and then shows “-„ (negative) and “-1” (minus one). The example below shows how to change a parameter from the actual setting of 1024 to the new setting of 250 000.

This example assumes that you have already selected the parameter group and the parameter number, and that you actually read the parameter value in the display.

Highlighted digits appear on colored background.

Step	Display	Key action	Comment
00	001024		Display of actual parameter setting, last digit is highlighted
01		 4 x	Scroll last digit down to 0
02	001020		Shift cursor to left
03	001020	 2 x	Scroll highlighted digit down to 0
04	001000	 2 x	Shift cursor 2 positions left
05	001000		Scroll highlighted digit down to 0
06	000000		Shift cursor left
07	000000	 5 x	Scroll highlighted digit up to 5
08	050000		Shift cursor left
09	050000	 2 x	Scroll highlighted digit up to 2
10	250000		Save new setting and return to the parameter number level

5.4. Code Protection against Unauthorized Keypad Access

Parameter group F11 allows to define an own locking code for each of the parameter menus. This permits to limit access to certain parameter groups to specific persons only.

When accessing a protected parameter group, the display will first show "CODE" and wait for your entry. To continue keypad operations you must now enter the code which you have stored before, otherwise the unit will return to normal operation again.

After entering your code, press the ENTER key and keep it down until the unit responds. When your code was correct, the response will be "YES" and the menu will work normally. With incorrect code the response will be "NO" and the menu remains locked.

5.5. Return from the Programming Levels and Time-Out Function



At any time the PROG key sets the menu one level up and finally returns to normal operation. The same step occurs automatically via the time-out function, when during a period of 10 seconds no key has been touched.

Termination of the menu by automatic time-out will not store new settings, unless they have already been stored by the PROG key after editing.

5.6. Reset all Parameters to Factory Default Values

Upon special need it may be desirable to set all parameters back to their original factory settings (e.g. because you have forgotten your access code, or by too many change of settings you have achieved a complex parameter state). Default values are indicated in the parameter tables shown later.

To reset the unit to default, please take the following steps:

- Switch power off
- Press  and  simultaneously
- Switch power on while you keep down both keys



Where you decide to take this action, please note that all parameters and settings will be lost, and that you will need to run a new setup procedure again.

6. Menu Structure and Description of Parameters

All parameters are arranged in a reasonable order of functional groups (F01 to F11)
 You must only set those parameters which are really relevant for your specific application.
 Unused parameters can remain as they actually are.

6.1. Summary of the Menu

This section shows a summary of the parameter groups.

Group	Function	Group	Function
F01	Function 1 Settings	F03	Function 3 Settings
000	Set Speed 1.1	032	Set Speed 1.1
001	Set Speed 1.2	033	Set Speed 1.2
002	Set Speed 2.1	034	Set Speed 2.1
003	Set Speed 2.2	035	Set Speed 2.2
004	Setpoint Counter 1	036	Setpoint Counter 1
005	Setpoint Counter 2	037	Setpoint Counter 2
006	Differential Setpoint	038	Differential Setpoint
007	Switch Event 1	039	Switch Event 1
008	Switch Event 2	040	Switch Event 2
009	Switch Event 3	041	Switch Event 3
010	Switch Event 4	042	Switch Event 4
011	Switch on Delay	043	Switch on Delay
012	Pulse Time	044	Pulse Time
013	Lock Function	045	Lock Function
014	Polarity	046	Polarity
F02	Function 2 Settings	F04	Function 4 Settings
016	Set Speed 1.1	048	Set Speed 1.1
017	Set Speed 1.2	049	Set Speed 1.2
018	Set Speed 2.1	050	Set Speed 2.1
019	Set Speed 2.2	051	Set Speed 2.2
020	Setpoint Counter 1	052	Setpoint Counter 1
021	Setpoint Counter 2	053	Setpoint Counter 2
022	Differential Setpoint	054	Differential Setpoint
023	Switch Event 1	055	Switch Event 1
024	Switch Event 2	056	Switch Event 2
025	Switch Event 3	057	Switch Event 3
026	Switch Event 4	058	Switch Event 4
027	Switch on Delay	059	Switch on Delay
028	Pulse Time	060	Pulse Time
029	Lock Function	061	Lock Function
030	Polarity	062	Polarity

Group	Function	Group	Function
F05	Logical Inputs Delay Settings	F08	Command Setting
064	Login 1 On Delay	106	Key Up Action
065	Login 1 Off Delay	107	Key Down Action
066	Login 2 On Delay	108	Key Enter Action
067	Login 2 Off Delay	109	Input 1 Configuration
068	Login 3 On Delay	110	Input 1 Action
069	Login 3 Off Delay	111	Input 2 Configuration
070	Login 4 On Delay	112	Input 2 Action
071	Login 4 Off Delay	113	Input 3 Configuration
072	Login 5 On Delay	114	Input 3 Action
073	Login 5 Off Delay	115	Input 4 Configuration
074	Login 6 On Delay	116	Input 4 Action
075	Login 6 Off Delay	117	Target Function 1
F06	Encoder 1 Settings	118	Target Function 2
076	Factor Counter 1	119	Target Function 3
077	Multi. Counter 1	120	Target Function 4
078	DP Counter 1	121	Target Status 1
079	Dir Window Counter 1	122	Target Status 2
080	Multi. Speed 1	123	Target Status 3
081	Divi. Speed 1	124	Target Status 4
082	Offset Speed 1	125	Release Action
083	DP Speed 1	126	Freeze Action
084	Sampling Time 1	F09	Serial Communication
085	Wait Time 1	128	Unit Number
086	Average Cycles 1	129	Serial Baud Rate
087	Encoder Properties 1	130	Serial Format
088	Edge Counting 1	F10	Special Functions
089	Counting Direction 1	134	Input Filter
F07	Encoder 2 Settings	135	Trigger Threshold 1
091	Factor Counter 2	136	Trigger Threshold 2
092	Multi. Counter 2	137	Brightness
093	DP Counter 2	138	Display Time
094	Dir Window Counter 2	139	Frequency Control
095	Multi. Speed 2	140	Power Down
096	Divi. Speed 2		Keypad Protection Codes
097	Offset Speed 2	143	Protect Group F01
098	DP Speed 2	144	Protect Group F02
099	Sampling Time 2	145	Protect Group F03
100	Wait Time 2	146	Protect Group F04
101	Average Cycles 2	147	Protect Group F05
102	Encoder Properties 2	148	Protect Group F06
103	Edge Counting 2	149	Protect Group F07
104	Counting Direction 2	150	Protect Group F08
		151	Protect Group F09
		152	Protect Group F10
		153	Protect Group F11

6.2. Description of the Parameters

6.2.1. Settings for Switching Function 1

F01		Range	Default
F01.000	Set Speed 1.1 First Setpoint for a switching condition of Function1 in dependence of the encoder1 speed	0 ... 999 999	11001
F01.001	Set Speed 1.2 Second Setpoint for a switching condition of Function1 in dependence of the encoder1 speed	0 ... 999 999	11002
F01.002	Set Speed 2.1 First Setpoint for a switching condition of Function1 in dependence of the encoder2 speed	0 ... 999 999	21001
F01.003	Set Speed 2.2 Second Setpoint for a switching condition of Function1 in dependence of the encoder2 speed	0 ... 999 999	21002
F01.004	Setpoint Counter 1 Value for comparison with the actual position of encoder 1 for a switching condition of Function1	0 ... 999 999	31000
F01.005	Setpoint Counter 2 Value for comparison with the actual position of encoder 1 for a switching condition of Function1	0 ... 999 999	41000
F01.006	Differential Setpoint Value for comparison with the actual position difference (encoder 1 - encoder 2) for a switching condition of Function1	0 ... 999 999	51000

F01		Range	Default
F01.007	Switch Condition 1	Are automatically set by the assignment screen of OS3.2 and should not be modified	
F01.008	Switch Condition 2		
F01.009	Switch Condition 3		
F01.010	Switch Condition 4		
F01.011	Switch on Delay Delay time between event appearance and switching response of Function 1. 0 = immediate response	0.000 ... 9.999 (sec.)	0.000
F01.012	Pulse Time Duration time of Switching Function 1 0 = static operation	0.000 ... 9.999 (sec.)	0.000
F01.013	Lock Function	0 ... 1	0
	0= Normal function (no catch) 1= Catch function: Once Function 1 is activated only the external command "Release Function" or power off can clear the switching state		
F01.014	Polarity	0 ... 1	0
	0= True Events set Function 1 to ON		
	1= True Events set Function 1 to OFF		

6.2.2. Settings for Switching Function 2 (Description see Function 1)

F02		Range	Default
F02.016	Set Speed 1.1	0 ... 999 999	12001
F02.017	Set Speed 1.2	0 ... 999 999	12002
F02.018	Set Speed 2.1	0 ... 999 999	22001
F02.019	Set Speed 2.2	0 ... 999 999	22002
F02.020	Setpoint Counter 1	0 ... 999 999	32000
F02.021	Setpoint Counter 2	0 ... 999 999	42000
F02.022	Differential Setpoint	0 ... 999 999	52000
F02.023	Switch Condition 1	Are set by the assignment screen of OS3.2 and should not be modified	
F02.024	Switch Condition 2		
F02.025	Switch Condition 3		
F02.026	Switch Condition 4		
F02.027	Switch on Delay	0.000 ... 9.999	0.000
F02.028	Pulse Time	0.000 ... 9.999	0.000
F02.029	Lock Function	0 ... 1	0
F02.030	Polarity	0 ... 1	0

6.2.3. S Settings for Switching Function 3 (Description see Function 1)

F03		Range	Default
F03.032	Set Speed 1.1	0 ... 999 999	13000
F03.033	Set Speed 1.2	0 ... 999 999	23000
F03.034	Set Speed 2.1	0 ... 999 999	23000
F03.035	Set Speed 2.2	0 ... 999 999	23000
F03.036	Setpoint Counter 1	0 ... 999 999	33000
F03.037	Setpoint Counter 2	0 ... 999 999	43000
F03.038	Differential Setpoint	0 ... 999 999	53000
F03.039	Switch Condition 1	Are set by the assignment screen of OS3.2 and should not be modified	
F03.040	Switch Condition 2		
F03.041	Switch Condition 3		
F03.042	Switch Condition 4		
F03.043	Switch on Delay	0.000 ... 9.999	0.000
F03.044	Pulse Time	0.000 ... 9.999	0.000
F03.045	Lock Function	0 ... 1	0
F03.046	Polarity	0 ... 1	0

6.2.4. Settings for Switching Function 4 (Description see Function 1)

F04		Range	Default
F04.048	Set Speed 1.1	0 ... 999 999	14000
F04.049	Set Speed 1.2	0 ... 999 999	24000
F04.050	Set Speed 2.1	0 ... 999 999	24000
F04.051	Set Speed 2.2	0 ... 999 999	24000
F04.052	Setpoint Counter 1	0 ... 999 999	34000
F04.053	Setpoint Counter 2	0 ... 999 999	44000
F04.054	Differential Setpoint	0 ... 999 999	54000
F04.055	Switch Condition 1	Are set by the assignment screen of OS3.2 and should not be modified	
F04.056	Switch Condition 2		
F04.057	Switch Condition 3		
F04.058	Switch Condition 4		
F04.059	Switch on Delay	0.000 ... 9.999	0.000
F04.060	Pulse Time	0.000 ... 9.999	0.000
F04.061	Lock Function	0 ... 1	0
F04.062	Polarity	0 ... 1	0

6.2.5. Delay setting for logical Inputs

F05		Range	Default
F05.064	Login 1 On Delay The input must be HIGH for at least this delay time to set the internal input state to high. 0 = no delay, immediate response	0.000 ... 9.999 (sec.)	0.000
F05.065	Login 1 Off Delay The input must be LOW for at least this delay time to set the internal input state to low. 0 = no delay, immediate response	0.000 ... 9.999 (sec.)	0.000
F05.066	Login 2 On Delay (see Login 1 On Delay)	0.000 ... 9.999	0.000
F05.067	Login 2 Off Delay (see Login 1 Off Delay)	0.000 ... 9.999	0.000
F05.068	Login 3 On Delay (see Login 1 On Delay)	0.000 ... 9.999	0.000
F05.069	Login 3 Off Delay (see Login 1 Off Delay)	0.000 ... 9.999	0.000
F05.070	Login 4 On Delay (see Login 1 On Delay)	0.000 ... 9.999	0.000
F05.071	Login 4 Off Delay (see Login 1 Off Delay)	0.000 ... 9.999	0.000
F05.072	Login 5 On Delay (see Login 1 On Delay)	0.000 ... 9.999	0.000
F05.073	Login 5 Off Delay (see Login 1 Off Delay)	0.000 ... 9.999	0.000
F05.074	Login 6 On Delay (see Login 1 On Delay)	0.000 ... 9.999	0.000
F05.075	Login 6 Off Delay (see Login 1 Off Delay)	0.000 ... 9.999	0.000

6.2.6. Encoder 1 Settings

F06		Range	Default
F06.076	Factor Counter 1 *) Impulse scaling factor for encoder 1	0.00001 ... 9.99999	1.00000
F06.007	Multi. Counter 1 *) Multiple impulse count of every impulse	1 ... 99	1
F06.008	DP Counter 1 Decimal point position when displaying the counter value of encoder 1 (see also chapter 7.)	0 ... 5	0
F06.009	Dir Window Counter 1 In order to achieve a stable indication of the actual direction of rotation even under vibration and mechanical oscillation, this parameter provides setting of an impulse window. Before detecting a direction or changing the direction signal, the unit must receive a consecutive number of impulses in the corresponding direction.	1 ... 99	4

*) Affects the position and differential counters only, but not the speed measurement

**) Affects the speed measurement only, but not the position or differential counters

F06		Range	Default
F06.080	Multi. Speed 1 **)	0 ... 999 999	1
F06.081	Divi. Speed 1 **)	0 ... 999 999	1
F06.082	Offset Speed 1 **)	-99 999 ... 99 999	0
	Parameters F06.080 to F06.082 are used to scale the frequency of encoder 1 (XXXXX.X Hz) to customer units. $DisplayValue = \frac{Frequency1 \times F06.080}{F06.081} + F06.082$		
F06.083	DP Speed 1 Decimal point position when displaying the speed value of encoder 1 (see also chapter 7.)	0 ... 5	0
F06.084	Sampling Time 1 **) Minimum time base to sample the input frequency of encoder 1 (sec.)	0.001 ... 9.999	0.010
F06.085	Wait Time 1 **) Time to wait before unit detects zero speed (sec.) Impulse distances greater than this time will result in zero speed detection (standstill)	0.001 ... 9.999	0.100
F06.086	Filter 1 **) Selects the degree of filtering for smoothing unstable input frequencies	0 ... 4	0
	0= Filter OFF (no smoothing)		
	1= T (63%) = 1,9 ms with Sampling Time = 1ms		
	2= T (63%) = 3,8 ms with Sampling Time = 1ms		
	3= etc.		
	7= T (63%) = 122ms with Sampling Time = 1ms (very slow response to frequency changes)		
F06.087	Encoder Properties 1	0 ... 1	1
	0= Impulses A, /A, B, /B (2 x 90°) differential.		
	1= Impulses A, B (2 x 90°) single-ended		
F06.088	Edge Counting 1 *)	0 ... 2	0
	0= Simple (x1)		
	1= Double (x2) for position only		
	2= Full quadrature (x4) for position only		
F06.089	Counting Direction 1 *)	0 ... 1	0
	0= Up when A leads B		
	1= Down when A leads B		

*) Affects the position and differential counters only, but not the speed measurement

***) Affects the speed measurement only, but not the position or differential counters

6.2.7. Encoder 2 Settings (Description see "Encoder 1 Settings")

F07		Range	Default
F07.091	Factor Counter 2	0.00001 ... 9.99999	1.00000
F07.092	Multi. Counter 2	1 ... 99	1
F07.093	DP Counter 2	0 ... 5	0
F07.094	Dir Window Counter 2	1 ... 99	4
F07.095	Multi. Speed 2	0 ... 999 999	1
F07.096	Divi. Speed 2	0 ... 999 999	1
F07.097	Offset Speed 2	-99 999 ... 99 999	0
F07.098	DP Speed 2	0 ... 5	0
F07.099	Sampling Time 2	0.001 ... 9.999	0.010
F07.100	Wait Time 2	0.001 ... 9.999	0.100
F07.101	Filter 2	0 ... 4	0
F07.102	Encoder Properties 2	0 ... 1	1
F07.103	Edge Counting 2	0 ... 2	0
F07.104	Counting Direction 2	0 ... 1	0

6.2.8. Key command assignments

F08		Range	Default	
F08.106	Key UP Action	0 ... 15	0	
	0=			No function
	1=			Reset counter 1 (encoder 1)
	2=			Reset counter 2 (encoder 2)
	3=			Reset difference [counter1 - counter2]
	4=			Scroll Display
	5=			n. a.
	6=			n. a.
	7=			Store EEPROM
	8=			Release Function Lock
	9=	Freeze Functions		
For more details about these functions see section 7.				
F08.107	Key Down Action	0 ... 15	0	
				See key „UP“
F08.108	Key Enter Action	0 ... 15	0	
				See key „UP“

n.a. = not applicable

6.2.9. Characteristics and functions of the Control Inputs

F08		Range	Default
F08.109	Input 1 Configuration	0 ... 7	0
	0= NPN (switch to -), function active LOW		
	1= NPN (switch to -), function active HIGH		
	2= NPN (switch to -), rising edge		
	3= NPN (switch to -), falling edge		
	4= PNP (switch to +), function active LOW		
	5= PNP (switch to +), function active HIGH		
	6= PNP (switch to +), rising edge		
7= PNP (switch to +), falling edge			
F08.110	Input 1 Action	0 ... 15	0
	0= No function		
	1= Reset counter 1 (encoder 1)		
	2= Reset counter 2 (encoder 2)		
	3= Reset difference [counter1 - counter2]		
	4= Scroll Display		
	5= n. a.		
	6= Keyboard Disable		
	7= Store EEPROM		
	8= Release Function Lock		
9= Freeze Function			
F08.111	Input 2 Configuration	See „Input 1“ (F08.109)	
F08.112	Input 2 Action	See „Input 1“ (F08.110)	
F08.113	Input 3 Configuration	See „Input 1“ (F08.109)	
F08.114	Input 3 Action	See „Input 1“ (F08.110)	
F08.115	Input 4 Configuration	0 – 3	 <p>no edge-triggered functions are possible with Input 4</p>
	0= NPN (switch to -) function active LOW		
	1= NPN (switch to -) function active HIGH		
	2= PNP (switch to +), function active LOW		
	3= PNP (switch to +), function active HIGH		
F08.116	Input 4 Action	See „Input 1“ (F08.110)	



- Unconnected NPN inputs are always HIGH (internal pull-up resistor)
Unconnected PNP inputs are always LOW (internal pull-down resistor)

n.a. = not applicable

F08		Range	Default
F08.117	Target Function 1 Output assignment for Function 1	0 ... 255 *)	1+16=17
F08.118	Target Function 2 Output assignment for Function 2	1 => Relay 1	2+32=34
F08.119	Target Function 3 Output assignment for Function 3	2 => Relay 2	4+64=68
F08.120	Target Function 4 Output assignment for Function 4	4 => Relay 3	8+128=136
F08.121	Target Status 1 Output assignment for Status 1	8 => Relay 4	0
F08.122	Target Status 2 Output assignment for Status 2	16 => Output 1	0
F08.123	Target Status 3 Output assignment for Status 3	32 => Output 2	0
F08.124	Target Status 4 Output assignment for Status 4	64 => Output 3	0
F08.125	Release Action (Release Latch of Functions) Parameter to define which of the functions should be released from Latch state by external command	0 ... 15	0
	0= no Function	4-bit binary code: 1 => Function 1 2 => Function 2 4 => Function 3 8 => Function 4	
	1= Release Latch of Function 1		
	2= Release Latch of Function 2		
	3= Release Latch of Function 1 and Function 2		
	4= Release Latch of Function 3		
	8= Release Latch of Function 4		
	15= Release Latch of all Functions		
F08.126	Freeze Action Parameter to define which of the functions should be frozen upon external command	0 ... 15	0
	0= no Function	4-bit binary code: 1 => Function 1 2 => Function 2 4 => Function 3 8 => Function 4	
	1= Freeze Function 1		
	2= Freeze Function 2		
	3= Freeze Function 1 and Function 2		
	4= Freeze Function 3		
	8= Freeze Function 4		
	15= Freeze all Functions		



*) **Setting via 8-bit binary code** (see chapter 3.4).

It is possible to assign several outputs to one function.

It is also possible to assign several functions to the same output.

Conflicting and incompatible settings must however be avoided.

The default settings shown above mean:

Function 1 operates Relay 1 and Output 1
Function 2 operates Relay 1 and Output 2
Function 3 operates Relay 1 and Output 3
Function 4 operates Relay 1 and Output 4

No outputs are assigned to the status signals.

6.2.10. Serial communication settings

F09		Range	Default
F09.128	Unit Number	11 ... 99	11
F09.129	Serial Baud Rate	0 ... 6	0
	0= 9600 Baud		
	1= 4800 Baud		
	2= 2400 Baud		
	3= 1200 Baud		
	4= 600 Baud		
	5= 19200 Baud		
	6= 38400 Baud		
F09.130	Serial Format	0 ... 9	0
	0= 7 Data, Parity even, 1 Stop		
	1= 7 Data, Parity even, 2 Stop		
	2= 7 Data, Parity odd, 1 Stop		
	3= 7 Data, Parity odd, 2 Stop		
	4= 7 Data, no Parity, 1 Stop		
	5= 7 Data, no Parity, 2 Stop		
	6= 8 Data, Parity even, 1 Stop		
	7= 8 Data, Parity odd, 1 Stop		
	8= 8 Data, no Parity, 1 Stop		
	9= 8 Data, no Parity, 2 Stop		

6.2.11. Special Functions

F10		Range	Default	
F10.134	Input filter: <u>must be set to "0"</u> .	0 ... 3	0	
F10.135	Trigger Threshold 1 for encoder1 inputs *)	30 ... 250	166	
F10.136	Trigger Threshold 2 for encoder2 inputs *)	30 ... 250	166	
F10.137	Brightness of the 7-segment LED display	0 ... 4	0	
	0=			100% of maximum brightness
	1=			80% of maximum brightness
	2=			60% of maximum brightness
	3=			40% of maximum brightness
	4=			20% of maximum brightness
F10.138	Display Time: Update time (sec.) for display only	0.005 ... 9.999	0.050	
F10.139	Frequency Control <u>must be set to "0"</u>	0 ... 1	0	
F10.140	Power Down (date retention of actual counter values in case of power-down)	0 ... 1	0	
	0=			No retention of positional and differential counters, Restart with zero upon power-up
	1=			Actual values of positional and differential counters are retained after power-down

*) Must be set to the default value (166) for any kind of input signals, except for single-ended TTL signals which require a setting of 35.



- Since some of above parameters are not for customer use, and to avoid accidental change of settings, above menu is protected by password (see 6.2.12)

6.2.12. Keypad protection codes

F11		Range	Default
F11.143	Protect group F01	0 = no protection 1 – 999 999 = Protection code for the actual parameter group	0
F11.144	Protect group F02		0
F11.145	Protect group F03		0
F11.146	Protect group F04		0
F11.147	Protect group F05		0
F11.148	Protect group F06		0
F11.149	Protect group F07		0
F11.150	Protect group F08		0
F11.151	Protect group F09		0
F11.152	Protect group F10		6078
F11.153	Protect group F11	6078	

7. Description of Commands

No.	Command	Description	Assignment to					
			Keypad	Input				
0	Do nothing		yes	yes				
1	Reset Counter 1	Sets the internal position counter for encoder input 1 to zero. (does not effect the differential counter)	yes	yes				
2	Reset Counter 2	Sets the internal position counter for encoder input 2 to zero. (does not effect the differential counter)	yes	yes				
3	Reset Difference	Sets the internal differential counter to zero. (does not effect counter 1 and counter2)	yes	yes				
4	Scroll Display	Selects the source of the digital display. The front LEDs indicate what the actual reading is	yes	yes				
					NO.	LED Display Value	L1	L2
					0	Display OFF (only two decimal points are lit)	OFF	OFF
					1	Actual Position Encoder 1	ON	OFF
					2	Actual Position Encoder 2	OFF	ON
					3	Actual Speed Encoder 1 (custom scaling)	blink	OFF
					4	Actual Speed Encoder 2 (custom scaling)	OFF	blink
					5	Actual Differential Counter	ON	ON
6	Actual Differential Counter (bar graph display, see diagram)	blink	blink					

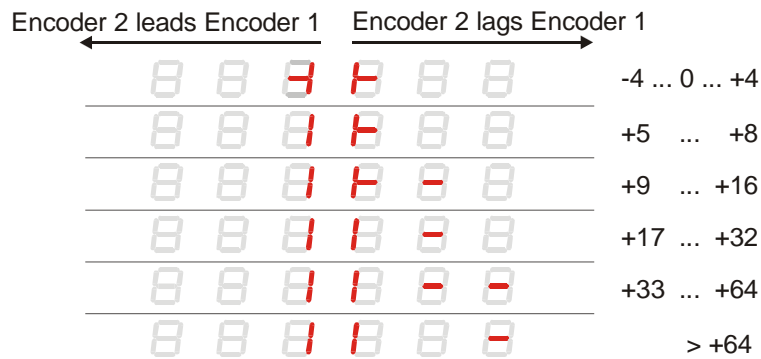

Bar graph display with reference to the actual differential counter

The diagram shows positive difference only (Encoder 2 lags Encoder 1). Negative errors are mirror-inverted.

No.	Command	Description	Assignment to	
			Keypad	Input
5	n.a.			
6	Parameter Disable	Disables the keypad for any parameter access. Only commands assigned to the keypads will be accessible	no	yes
7	Store EEPROM	Stores actual operational settings to the EEPROM, so they remain available also after power down.	yes	yes
8	Release Function Lock	Releases all selected switching functions from their latch state	yes	yes
9	Freeze Function *)	Freezes all selected functions to their actual switching state	yes	yes

n.a. = not applicable



***) After a power-down situation the "Freeze" function will operate as follows:**

- a. If upon power recurrence the external freeze input is still active, all selected Functions will return with their previous (frozen) state
- b. If upon power recurrence the external freeze command is no more active, the "Freeze" state will be overridden and all functions will follow the actual process state.
- c. During power-up of the unit, for a short period of about 1 sec all outputs may temporary take an undefined switching state (initialization phase)

8. Hints for Scaling of the Unit

The scaling parameters of the unit affect the **display of the actual values** as well as the associated **Setpoints** for the switching functions. In principle, there are two fully independent sets of scaling parameters:

- a. Scaling parameters for frequencies and speeds
- b. Scaling parameters for counters, positions and differential positions



Where your application uses setpoints for control of speeds, you must use the speed dimensions according to your speed scaling to enter the set speeds of the corresponding encoder

Where your application uses positional or differential counter setpoints for control of distances or errors, you must use the positional dimensions according to your counter scaling to enter the setpoints of the corresponding encoder

8.1. Speed Scaling

Internally, the unit measures all speed-related values as a frequency with a resolution of 0.1 Hz. This numeric value is used as a basis for all further calculations.

When e.g. the actual frequency of an encoder is 1.5 kHz, the unit would internally use a value of 15 000.

You are free to attach any other dimensions to your speed measurements (e.g. RPM, m/min, miles/h etc.) by corresponding setting of the parameters F06.080 to F06.082 (encoder 1) or F07.095 to F07.097 (encoder 2)

Example: a frequency of 1.5 kHz on encoder input 1 should be converted to a speed scaling of 67.0 m/min. This means the internal value of „15 000“ must be converted to a value of „670“ (display of 67.0 requires a result of 670 which appears as 67.0 when the decimal point is switched on).

It is easy to understand that we only need to divide the basic frequency value by 15000, then multiply it again by 670 (F06.80 = 670 and F06.81 = 15 000). The Offset (F06.82) remains set to 0 (because frequency = 0 means at the same time speed = 0).

$$\text{Speed [1/10 m/min]} = f \text{ [1/10 Hz]} \times \frac{\boxed{670} \leftarrow (\text{F06.80})}{\boxed{15\ 000} \leftarrow (\text{F06.81})}$$

After setting the decimal point (F06.83 = 1), the speed display and all Set Speeds related to encoder 1 are set to a format xxx.x m/min (Set Speed 1.1, Set Speed 1.2 und Set Speed 1). This speed scaling will neither affect the position counters nor the differential counter of the unit.

8.2. Standstill Definition (Wait-Time)

This definition is related to the input frequency only and does not depend on any other scaling parameters. It is necessary to set the period time of the minimum frequency that the unit still should consider as "motion".

Where e.g. we set „Wait Time1“ to 0.1 sec., the unit will declare all encoder1 frequencies lower than 10 Hz for "Motion" and all frequencies higher than 10 Hz for "Standstill".

8.3. Scaling of the Position Counters

8.3.1. Direct impulse counting

When you like the counters (Counter 1 and Counter 2) to count just the encoder increments without any scaling, please set the associated impulse scaling factors (F06.76 respectively F07.091) to 1,00000, and set the associated impulse multiplier (F06.007 respectively F07.092) to „1“. All positional and differential counts as well as the attached setpoints (Setpoint Position und Differential Setpoint) will then be straight incremental.*)

8.3.2. Differential evaluation

When the two encoders provide different ppr numbers, or when a gearbox is installed between encoder1 and encoder2, any differential evaluation requires adaptation of both encoders by proper scaling.**)

You must know the accurate number of impulses generated by both encoders in one cycle or on a defined distance (e.g. one full revolution of the slower encoder or a traveling distance of 1000 mm). The following formula applies:

$$\text{Impulse count encoder1} \times \text{Factor Counter1} = \text{Impulse count encoder2} \times \text{Factor Counter2}$$

A simple solution exists by using the figures of the impulse count on one side as a factor setting on the other side. If e.g. on a fixed traveling distance encoder1 would generate 20 000 impulses whereas encoder2 would generate only 300 impulses, use 0.03000 for the Factor Counter1 and 2.00000 for the Factor Counter2. For precision applications it may be important to avoid cumulating errors caused by ratios with more than 5 decimal positions.

8.3.3. Scaling to customer engineering units

The parameters „Factor Counter“ and „Multi Counter“ are used the same way for scaling of the position counters to customer units. If e.g. you like to receive a 0.1 mm scaling with an existing resolution of 20 000 increments per meter, just set the corresponding factor to 0.50000 (20 000 x 0.5 = 10 000, which appears as 1000.0 mm when you switch the decimal point on)

*) under consideration of the selected edge-counting mode (F06.088 respectively F07.103)

***) only important for differential evaluations (encoder 1 – encoder 2)

9. Specifications

AC power supply	:	24 V~ +/-10%, 15 VA
DC power supply	:	24V- (17 – 40V), approx. 100 mA (+ encoders)
Aux. encoder supply outputs:		2 x 5,2 VDC, 150 mA each 2 x 24V DC, 120 mA each
Inputs	:	2 universal encoder inputs, A, /A, B, /B each 4 digital control inputs HTL/PNP-NPN (Ri = 3.3 kΩ) Low < 2.5 V, High > 10 V, min. pulse width 50 μsec. 6 logical inputs HTL / PNP only (Ri = 3.3 kΩ) Low < 2.5 V, High > 10 V
Counting frequency (per encoder)	:	RS422 and TTL differential: 500 kHz HTL single ended: 200 kHz TTL single-ended: 200 kHz
Switching outputs	:	4 fast power transistors 5 - 30V, 350 mA (b) Response time < 1 msec. (a),
Relay outputs	:	4 relays (dry changeover contacts) (b) AC switching capability max. 250 V/ 1 A/ 250 VA DC switching capability max. 100 V/ 1A/ 100 W
Serial link	:	RS232, 2400 – 38400 Bauds
Ambient temperature	:	Operation: 0 - 45°C (32 – 113°F) Storage: -25 - +70°C (-13 – 158°F)
Housing	:	Norly UL94 – V-0
Display	:	6 Digit, LED, high- efficiency red, 15mm
Protection class front side	:	IP65
Protection class rear side	:	IP20
Screw terminals	:	Cross section max. 1.5 mm ² ,
Conformity and standards:		EMC 2004/108/EC: EN 61000-6-2 EN 61000-6-3 LV 2006/95/EC: EN 61010-1
Safety and Performance	:	MTBF (a): 56,8 (Temp. = 30°C / 86°F) λ fit: 2009

With a redundant configuration (e.g. two monitors in parallel), this product is suitable for use with safety-relevant applications

- (a) Continuous serial communication may temporary increase response times
- (b) Diode or RC filtering is mandatory when switching inductive loads

10. Dimensions

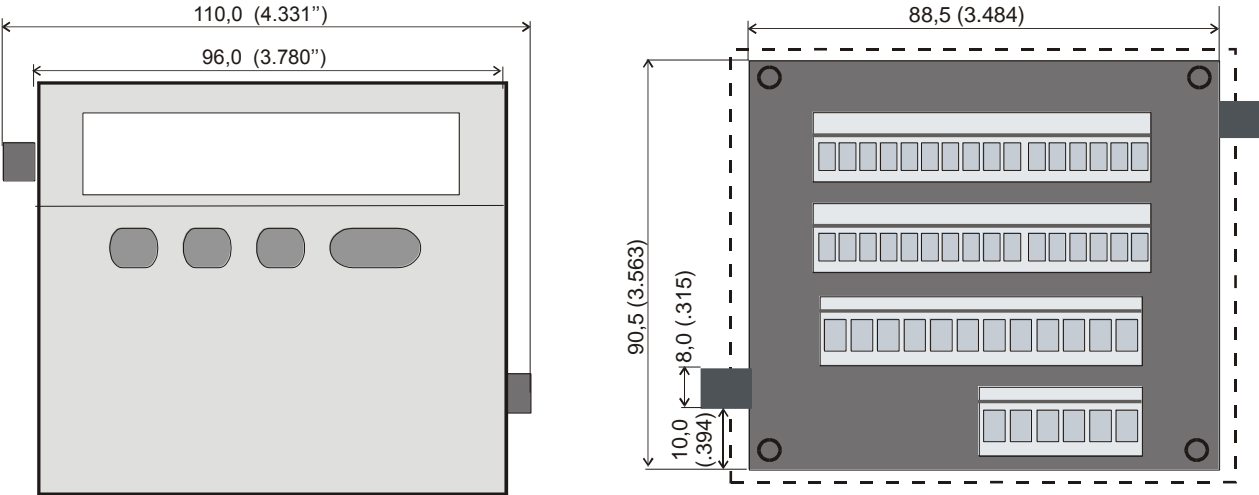

Panel cut out (b x h): 89 x 91 mm (3.504" wide x 3.583" high)

11. Serial Code List

11.1. Parameters and Settings

No.	Menu	Text	Code	Minimum	Maximum	Default
0	F01	Set Speed 1.1	A0	0	999999	11001
1	F01	Set Speed 1.2	A1	0	999999	11002
2	F01	Set Speed 2.1	A2	0	999999	21001
3	F01	Set Speed 2.2	A3	0	999999	21002
4	F01	Setpoint Counter 1	A4	0	999999	31000
5	F01	Setpoint Counter 2	A5	0	999999	41000
6	F01	Differential Setpoint	A6	0	999999	51000
7	F01	Switch Event 1	A7	-2147483648	2147483647	0
8	F01	Switch Event 2	A8	-2147483648	2147483647	0
9	F01	Switch Event 3	A9	-2147483648	2147483647	0
10	F01	Switch Event 4	B0	-2147483648	2147483647	0
11	F01	Switch on Delay	B1	0	9999	0
12	F01	Pulse Time	B2	0	9999	0
13	F01	Lock Function	B3	0	1	0
14	F01	Polarity	B4	0	1	0
15	F01	Reserved	B5	0	999999	0
16	F02	Set Speed 1.1	B6	0	999999	12001
17	F02	Set Speed 1.2	B7	0	999999	12002
18	F02	Set Speed 2.1	B8	0	999999	22001
19	F02	Set Speed 2.2	B9	0	999999	22002
20	F02	Setpoint Counter 1	C0	0	999999	32000
21	F02	Setpoint Counter 2	C1	0	999999	42000
22	F02	Differential Setpoint	C2	0	999999	52000
23	F02	Switch Event 1	C3	-2147483648	2147483647	0
24	F02	Switch Event 2	C4	-2147483648	2147483647	0
25	F02	Switch Event 3	C5	-2147483648	2147483647	0
26	F02	Switch Event 4	C6	-2147483648	2147483647	0
27	F02	Switch on Delay	C7	0	9999	0
28	F02	Pulse Time	C8	0	9999	0
29	F02	Lock Function	C9	0	1	0
30	F02	Polarity	D0	0	1	0
31	F02	Reserved	D1	0	999999	0
32	F03	Set Speed 1.1	D2	0	999999	13000
33	F03	Set Speed 1.2	D3	0	999999	23000
34	F03	Set Speed 2.1	D4	0	999999	13000
35	F03	Set Speed 2.2	D5	0	999999	23000
36	F03	Setpoint Counter 1	D6	0	999999	33000
37	F03	Setpoint Counter 2	D7	0	999999	43000
38	F03	Differential Setpoint	D8	0	999999	53000

No.	Menu	Text	Code	Minimum	Maximum	Default
39	F03	Switch Event 1	D9	-2147483648	2147483647	0
40	F03	Switch Event 2	E0	-2147483648	2147483647	0
41	F03	Switch Event 3	E1	-2147483648	2147483647	0
42	F03	Switch Event 4	E2	-2147483648	2147483647	0
43	F03	Switch on Delay	E3	0	9999	0
44	F03	Pulse Time	E4	0	9999	0
45	F03	Lock Function	E5	0	1	0
46	F03	Polarity	E6	0	1	0
47	F03	Reserved	E7	0	999999	0
48	F04	Set Speed 1.1	E8	0	999999	14000
49	F04	Set Speed 1.2	E9	0	999999	24000
50	F04	Set Speed 2.1	F0	0	999999	14000
51	F04	Set Speed 2.2	F1	0	999999	24000
52	F04	Setpoint Counter 1	F2	0	999999	34000
53	F04	Setpoint Counter 2	F3	0	999999	44000
54	F04	Differential Setpoint	F4	0	999999	54000
55	F04	Switch Event 1	F5	-2147483648	2147483647	0
56	F04	Switch Event 2	F6	-2147483648	2147483647	0
57	F04	Switch Event 3	F7	-2147483648	2147483647	0
58	F04	Switch Event 4	F8	-2147483648	2147483647	0
59	F04	Switch on Delay	F9	0	9999	0
60	F04	Pulse Time	G0	0	9999	0
61	F04	Lock Function	G1	0	1	0
62	F04	Polarity	G2	0	1	0
63	F04	Reserved	G3	0	999999	0
64	F05	Login 1 On Delay	G4	0	9999	0
65	F05	Login 1 Off Delay	G5	0	9999	0
66	F05	Login 2 On Delay	G6	0	9999	0
67	F05	Login 2 Off Delay	G7	0	9999	0
68	F05	Login 3 On Delay	G8	0	9999	0
69	F05	Login 3 Off Delay	G9	0	9999	0
70	F05	Login 4 On Delay	H0	0	9999	0
71	F05	Login 4 Off Delay	H1	0	9999	0
72	F05	Login 5 On Delay	H2	0	9999	0
73	F05	Login 5 Off Delay	H3	0	9999	0
74	F05	Login 6 On Delay	H4	0	9999	0
75	F05	Login 6 Off Delay	H5	0	9999	0

No.	Menu	Text	Code	Minimum	Maximum	Default
76	F06	Factor Counter 1	00	1	999999	100000
77	F06	Multi. Counter 1	01	1	99	1
78	F06	DP Counter 1	02	0	5	0
79	F06	Dir Window Counter 1	03	1	99	4
80	F06	Multi. Speed 1	04	1	999999	1
81	F06	Divi. Speed 1	05	1	999999	1
82	F06	Offset Speed 1	06	-99999	99999	0
83	F06	DP Speed 1	07	0	5	0
84	F06	Sampling Time 1	08	1	9999	10
85	F06	Wait Time 1	09	1	9999	100
86	F06	Filter 1	10	0	7	0
87	F06	Encoder Properties 1	11	0	1	1
88	F06	Edge Counting 1	12	0	2	0
89	F06	Counting Direction 1	13	0	1	0
90	F06	Reserved	14	0	999999	0
91	F07	Factor Counter 2	15	1	999999	100000
92	F07	Multi. Counter 2	16	1	99	1
93	F07	DP Counter 2	17	0	5	0
94	F07	Dir Window Counter 2	18	1	99	4
95	F07	Multi. Speed 2	19	1	999999	1
96	F07	Divi. Speed 2	20	1	999999	1
97	F07	Offset Speed 2	21	-99999	99999	0
98	F07	DP Speed 2	22	0	5	0
99	F07	Sampling Time 2	23	1	9999	10
100	F07	Wait Time 2	24	1	9999	100
101	F07	Filter 2	25	0	7	0
102	F07	Encoder Properties 2	26	0	1	1
103	F07	Edge Counting 2	27	0	2	0
104	F07	Counting Direction 2	28	0	1	0
105	F07	Reserved	29	0	999999	0
106	F08	Key Up Action	30	0	16	0
107	F08	Key Down Action	31	0	16	0
108	F08	Key Enter Action	32	0	16	0
109	F08	Input 1 Configuration	33	0	7	0
110	F08	Input 1 Action	34	0	16	0
111	F08	Input 2 Configuration	35	0	7	0
112	F08	Input 2 Action	36	0	16	0
113	F08	Input 3 Configuration	37	0	7	0
114	F08	Input 3 Action	38	0	16	0
115	F08	Input 4 Configuration	39	0	3	0
116	F08	Input 4 Action	40	0	16	0

No.	Menu	Text	Code	Minimum	Maximum	Default
117	F08	Target Function 1	41	0	255	17
118	F08	Target Function 2	42	0	255	34
119	F08	Target Function 3	43	0	255	68
120	F08	Target Function 4	44	0	255	136
121	F08	Target Status 1	45	0	255	0
122	F08	Target Status 2	46	0	255	0
123	F08	Target Status 3 (Programming)	47	0	255	0
124	F08	Target Status 4 (READY)	48	0	255	0
125	F08	Release Action	49	0	15	0
126	F08	Freeze Action	50	0	15	0
127	F08	Reserved				
128	F09	Unit Number	90	11	99	11
129	F09	Serial Baud Rate	91	0	6	0
130	F09	Serial Format	92	0	9	0
131	F09	Reserved	I0	0	999999	0
132	F09	Reserved	I1	0	999999	0
133	F09	Reserved	I2	0	999999	0
134	F10	Input Filter	I3	0	3	0
135	F10	Trigger Threshold 1	I4	30	250	166
136	F10	Trigger Threshold 2	I5	30	250	166
137	F10	Brightness	I6	0	4	0
138	F10	Display Time	I7	5	9999	50
139	F10	Frequency Control	I8	0	1	0
140	F10	Power Down Mode	I9	0	1	1
141	F10	Reserved	J0	0	999999	0
142	F10	Reserved	J1	0	999999	0
143	F11	Protect Group F01	J2	0	999999	0
144	F11	Protect Group F02	J3	0	999999	0
145	F11	Protect Group F03	J4	0	999999	0
146	F11	Protect Group F04	J5	0	999999	0
147	F11	Protect Group F05	J6	0	999999	0
148	F11	Protect Group F06	J7	0	999999	0
149	F11	Protect Group F07	J8	0	999999	0
150	F11	Protect Group F08	J9	0	999999	0
151	F11	Protect Group F09	K0	0	999999	0
152	F11	Protect Group F10	K1	0	999999	6078
153	F11	Protect Group F11	K2	0	999999	6078
154	F11	Reserved	K3	0	999999	0
155	F11	Reserved	K4	0	999999	0
156	F11	Reserved	K5	0	999999	0
157	F11	Reserved	K6	0	999999	0
158	F11	Reserved	K7	0	999999	0

11.2. Control Commands

No.	Command	Code	Bit	Ser. access	Bus access	Remote access
0	Reset Counter A	60	0080	Yes	No	Yes
1	Reset Counter B	65	0040	Yes	No	Yes
2	Reset Difference	66	0020	Yes	No	Yes
3	Scroll Display	56	0010	Yes	No	Yes
4	Activate Data	67	0008	Yes	No	No
5	Keyboard Disable	57	0004	Yes	No	Yes
6	Store EEPROM	68	0002	Yes	No	Yes
7	Release Function Lock	58	0001	Yes	No	Yes
8	Freeze Function	59	8000	Yes	No	Yes
9	Reserved	55	4000	Yes	No	Yes
10	Reserved	61	2000	Yes	No	Yes
11	Reserved	62	1000	Yes	No	Yes
12	Reserved	54	0800	Yes	No	Yes
13	Reserved	63	0400	Yes	No	Yes
14	Reserved	64	0200	Yes	No	Yes

11.3. Actual Process Values

No.	Text	Code
1	Differential position (encoder 1 - encoder 2)	:1
2	Actual frequency of encoder 1 (in steps of 0.1 Hz)	:2
3	Actual frequency of encoder 2 (in steps of 0.1 Hz)	:3
4	Actual speed of encoder 1 (user units)	:4
5	Actual speed of encoder 1 (user units)	:5
6	Actual count of encoder 1 (position)	:6
7	Actual count of encoder 2 (position)	:7